

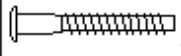











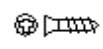

F
E
R
R
A
G
E
M

	CÓD.	FERRAGEM	QTDE.
A	1260	 7,0x70	12
B	8020	 7,0x130	08
C	4367	 1/4x130	08
D	4164	 PORCA ELÍPTICA	08
E	248	 CHAVE ALLEN	01
F	107	 PREGOS 10X10	45
G	1493	 TAMPA P/ ESTRUTURAL BRANCO	28
G	53	 TAMPA P/ ESTRUTURAL TECA	28
H	58	kappesberg	01
I	4214	 3,5x14 CHATO	02
J	85	 "L" DE METAL	01
L	8021	 CAPA 100 X 100 TECA	04
L	8023	 CAPA 100 X 100 TECA	04
M	2369	 LASTROS	11
N	347	 TRAVESSAS	04

"GARANTIA POR DEFEITO DE FABRICAÇÃO 6 MESES."

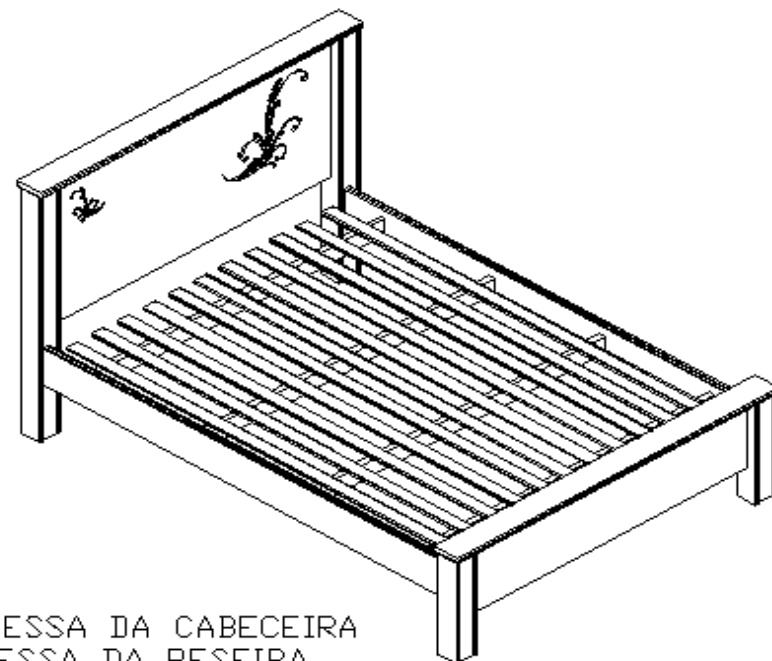

12709-TRAVESSA DA CABECEIRA
12710-TRAVESSA DA PESEIRA
12711-LATERAL DA CAMA
12712-CABECEIRA
12713-PESEIRA
12714-PEÇA MENOR DO PÉ BAIXO
12715-PEÇA MAIOR DO PÉ BAIXO
12716-PEÇA MENOR DO PÉ ALTO
12717-PEÇA MAIOR DO PÉ ALTO

↑
"OBS: Para solicitar assistência técnica, utilize o código da ferragem indicada."

◀
"OBS: Para solicitar assistência técnica, utilize o código das peças indicada."

OBS.: COLOCAR 1 "L" DE METAL NA CABECEIRA PARA FIXAR A TRAVESSA

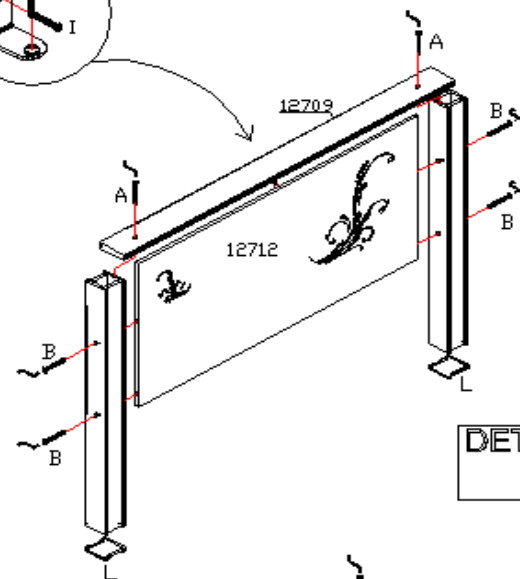
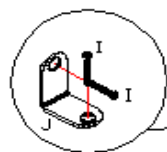

DETALHE DA MONTAGEM DA CABECEIRA

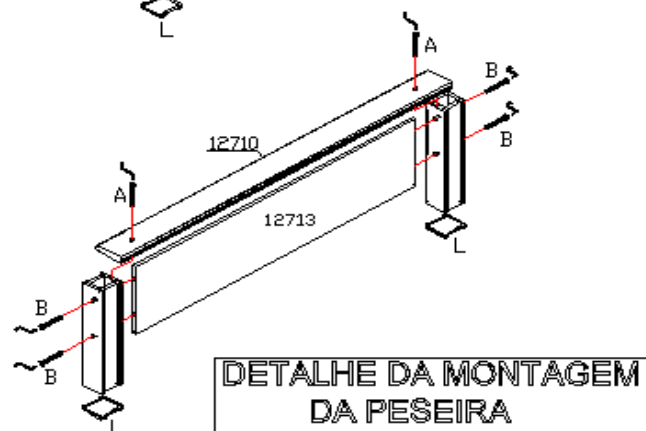

DETALHE DA MONTAGEM DA PESEIRA

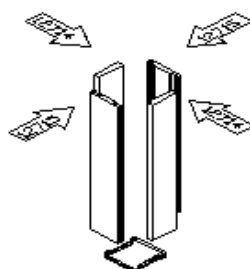

DETALHE DA MONTAGEM DOS PÉS

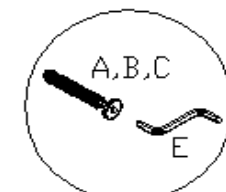
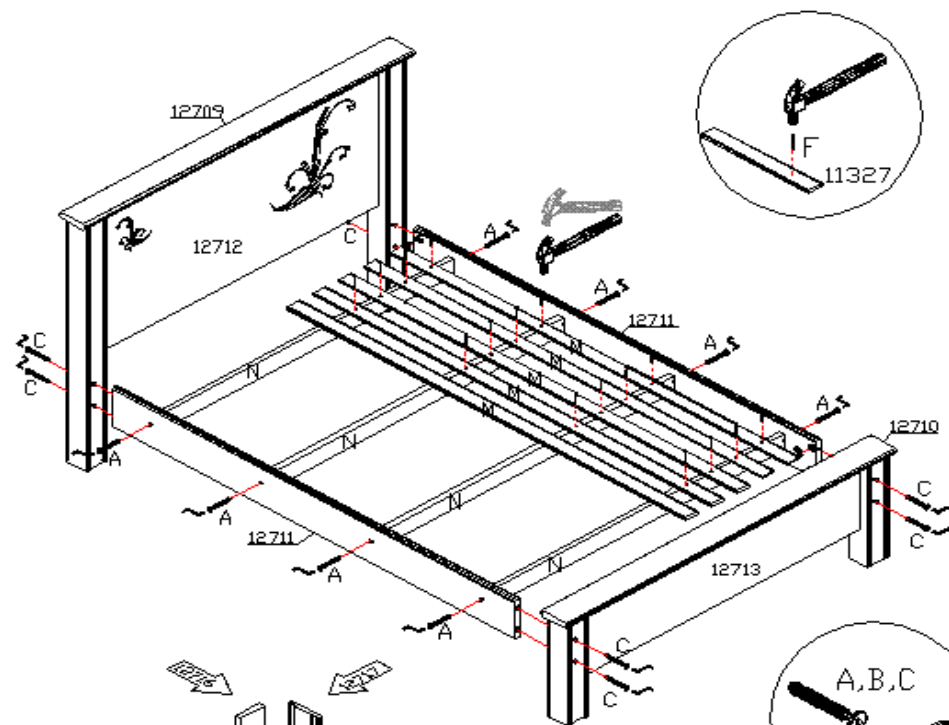

DETALHE DA MONTAGEM DOS PÉS