

05

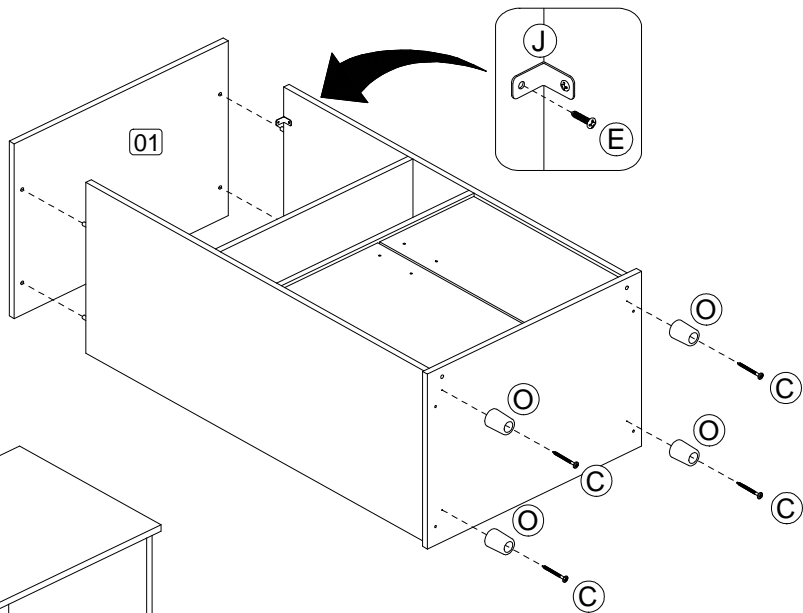

06

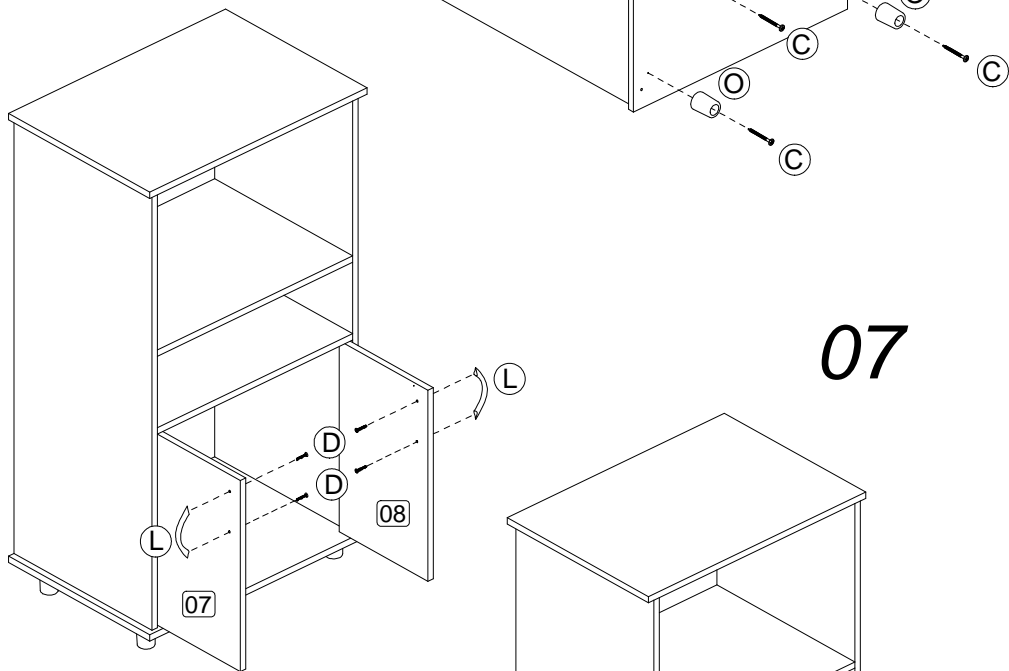

07

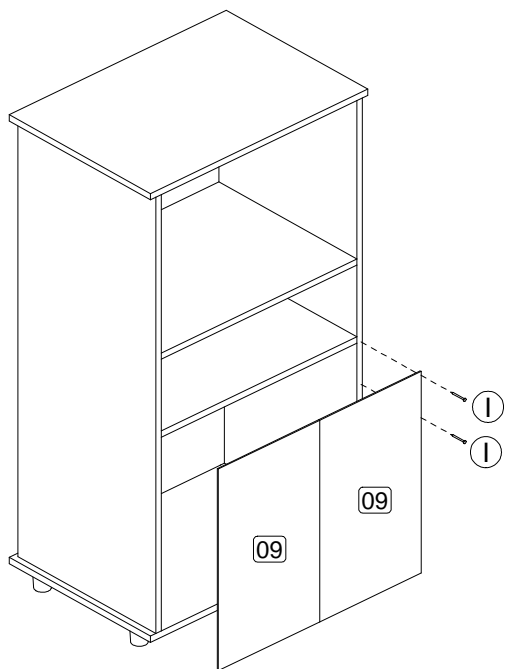

INSTRUÇÕES DE MONTAGEM
INSTRUCTIVO DE ARMADO
ASSEMBLY INSTRUCTIONS









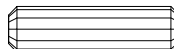
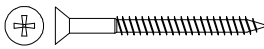
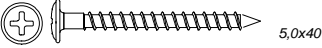
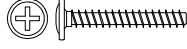

Armário Blumenau
Rack para Horno y Microondas
Microwave and Oven Rack

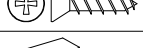
Modelo
Model
3206

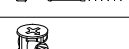

RST 470 - 203,3 - FONE: (0XX54) 3458.1300 - FAX: (0XX54) 3458.1304 - BENTO GONÇALVES - RS - BRASIL
 DÚVIDAS? ENVIE SEU E-MAIL PARA O SETOR DE ENGENHARIA DA POLITORNO: engenharia@politorno.com.br
 DUDAS? ENVIE SEU E-MAIL PARA EL SETOR DE ENGENHARIA DA POLITORNO: engenharia@politorno.com.br
 QUESTIONS? SEND YOUR E-MAIL TO ENG. SECTION OF POLITORNO: engenharia@politorno.com.br

KIT FERRAGEM
KIT HERRAJE
HARDWARE KIT

A	 8x30	16
B	 4,5x45	04
C	 5,0x40	04
D	 3,5x25	04
E	 3,5x14	08
F	 3,5x14	06
G	 02	02
H	 02	02
I	 10X10	28
J	 04	04
K	 04	04
L	 02	02
M	 02	02
N	 02	02
O	04	04

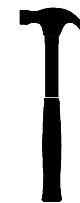

ANTES DE INICIAR A MONTAGEM, IDENTIFIQUE TODAS AS PEÇAS E ACESSÓRIOS.
 ANTES DE EMPEZA LA ASAMBLE, IDENTIFIQUE TODAS LAS PIEZAS Y ACCESORIOS.
 BEFORE STARTING THE ASSEMBLY, IDENTIFY ALL PARTS AND ACCESSORIES.

01

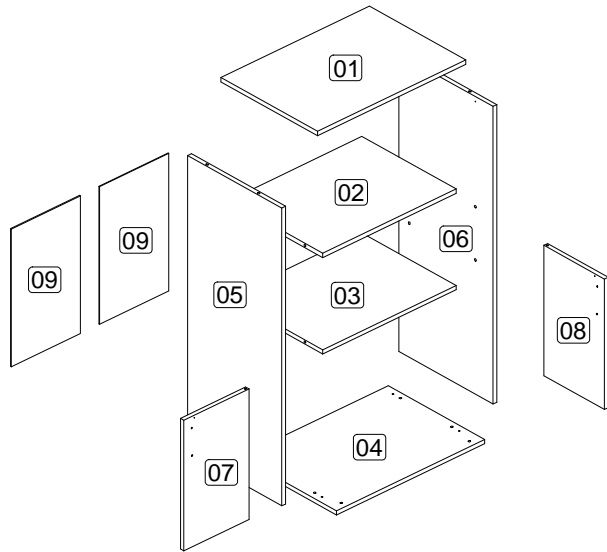

02

ETAPA DE PREPARAÇÃO DAS PEÇAS.
 FASE DE PREPARACIÓN DE LAS PIEZAS.
 STAGE OF PREPARATION OF THE PIECES.

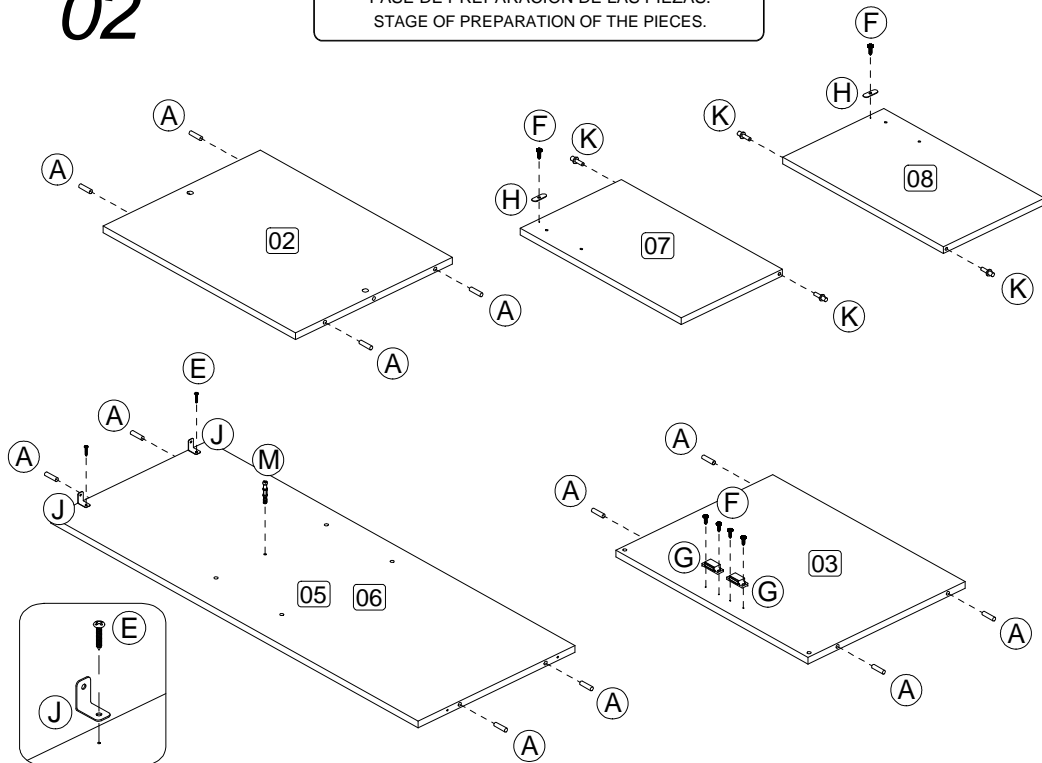

03

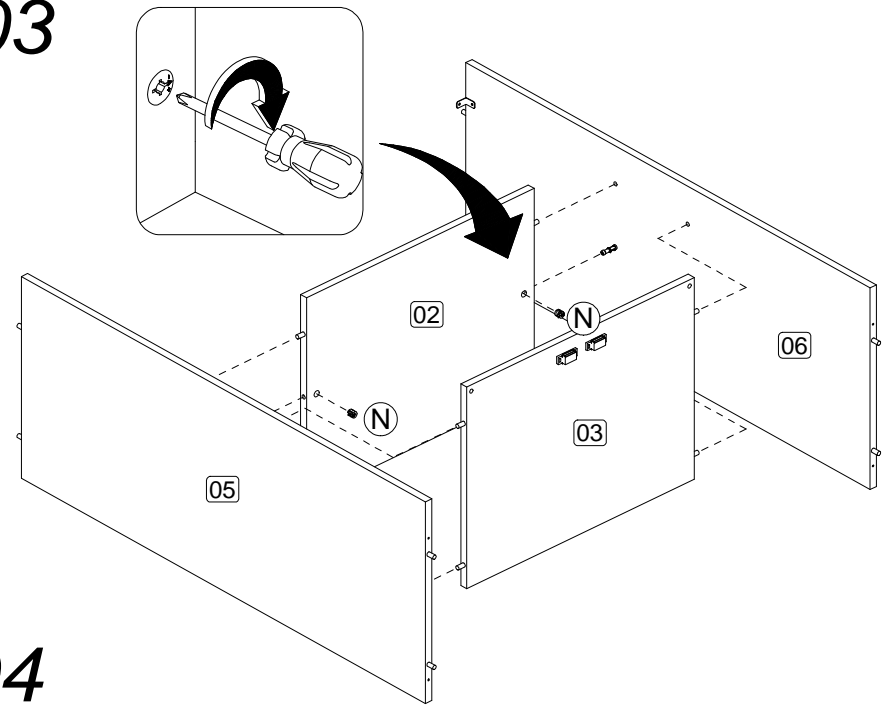

04

